



(GB) Assembly instructions

(PL) Instrukcja montażu

(DE) Montageanleitung

(CZ) Montážní návod

(FR) Notice de montage

(SK) Návod na montáž

(NL) Handleiding voor de montage

(HR) Montaže

(IT) Istruzioni di montaggio

(TR) Montaj talimat

(HU) Szerelési útmutató

(RO) Instrucțiuni de montaj

(ES) Instrucciones de montaje

(RU) Чинһдөүөч' дї өйһңрөө

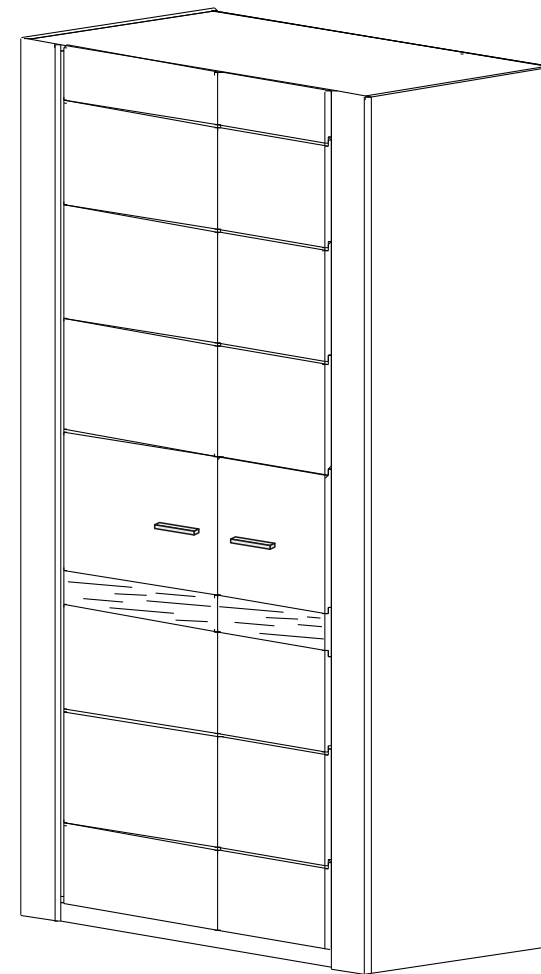
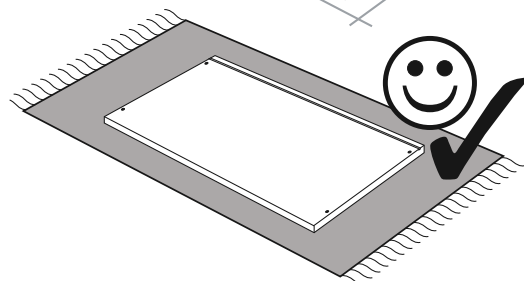
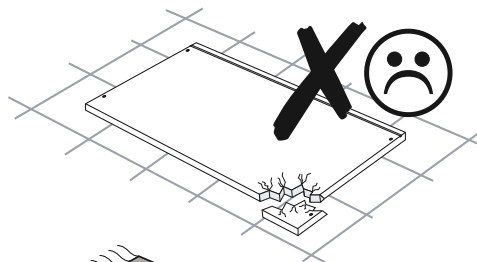
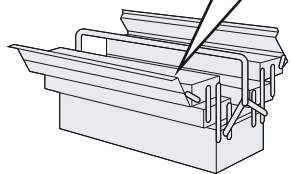
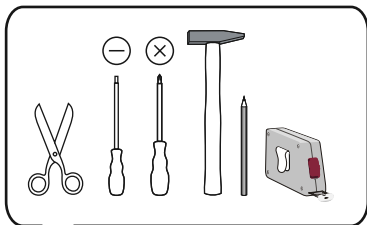
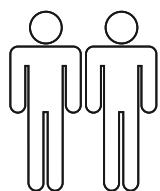

## Service • Assistenza • Dienstverlening • Serwis Servis • Szerviz • Servicio • Usluga • Нíđáčńír' Нёóчár

|  |                 |
|--|-----------------|
| Name • Nom • Nome • Naam • Nazwa<br>Jméno • Názov • Név • Denumire<br>Nombre • Ime • Isim • Írçarıđı | <b>VELVET</b>   |
| Nr. • No. • N° • říěřđ • Ć • Sz • Ne   | <b>SIDR26..</b> |
| Typ • Type • Tip • Tipus • Tipo • Нсđđ   | <b>70</b>       |
|  |                 |

shop • geschäft • boutique • sklep • winkel • řěřřçđı  
negozio • bolt • tienda • obchod • dućan • mađaza • magazin

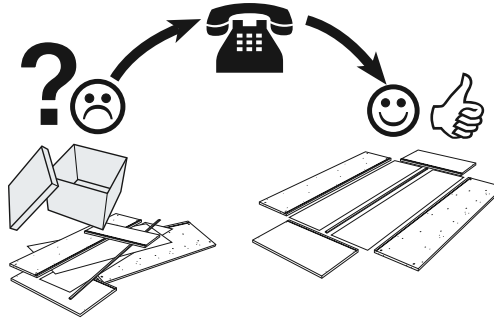

|   |                               |                                       |
|---|-------------------------------|---------------------------------------|
| <b>Z26</b><br>KR 90<br>x4                       | <b>T1</b><br>x36              | <b>U81</b><br>C1883 GS<br>96 mm<br>x2 |
| <b>Z26</b><br>KR 90<br><i>cichy domyk</i><br>x4 | <b>M1</b><br>x36              | <b>A2</b><br>x4<br>M4x25              |
| <b>D19</b><br>H 6<br>x8                         | <b>B1</b><br>fi 8x28<br>x41   | <b>J11</b><br>x2                      |
| <b>S9</b><br>4x16<br>x16                        | <b>C9</b><br>fi 20<br>x26     | <b>P16</b><br>4x16<br>x4              |
| <b>M6</b><br>x8                                 | <b>P2</b><br>3x16<br>x8       |                                       |
| <b>P3</b><br>3,5x16 mm<br>x8                    | <b>L1</b><br>x1               |                                       |
| <b>F7</b><br>x2                                 | <b>L3</b><br>45x15<br>x6      |                                       |
| <b>S4</b><br>3x16 mm<br>x2                      | <b>J21</b><br>L-1064 mm<br>x1 |                                       |
| <b>F15</b><br>x4                                |                               |                                       |

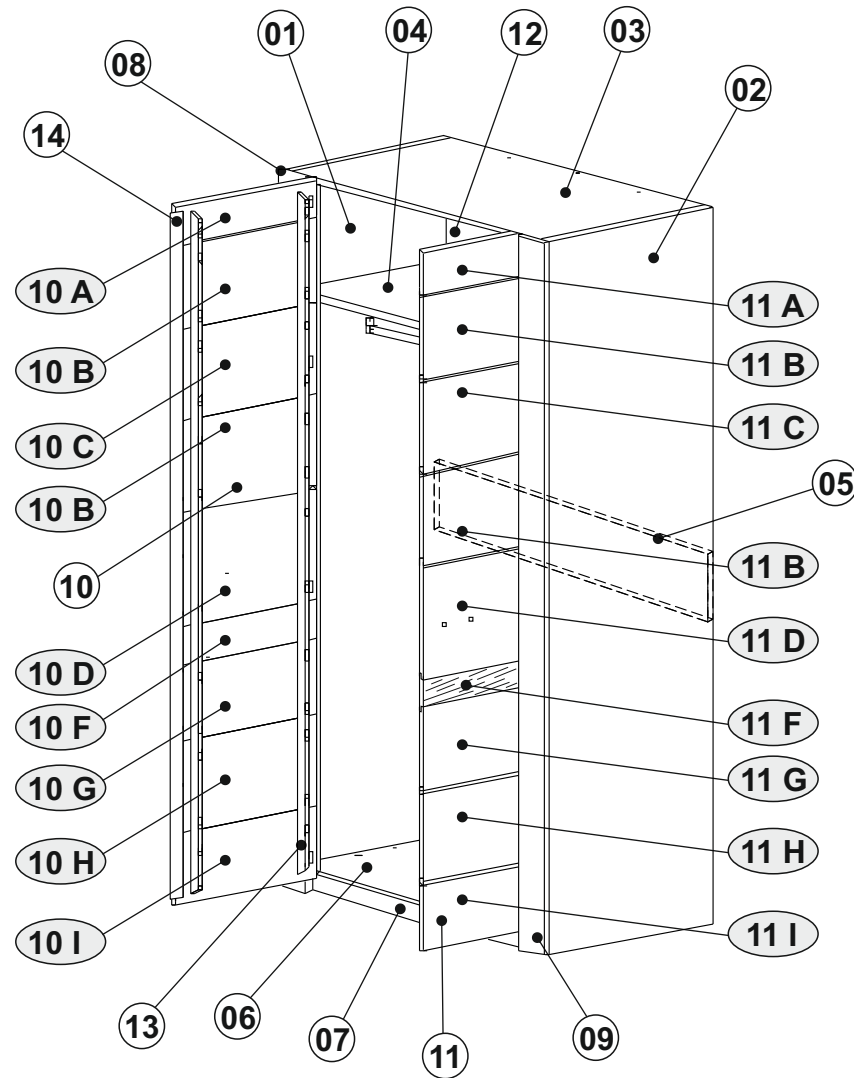
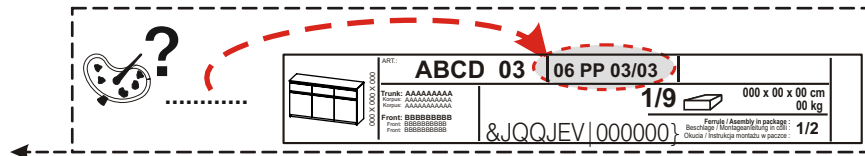



0 10 20 30 40 50 60 70 80 90 100 110 120 130 140 150 160 170 180 190 200

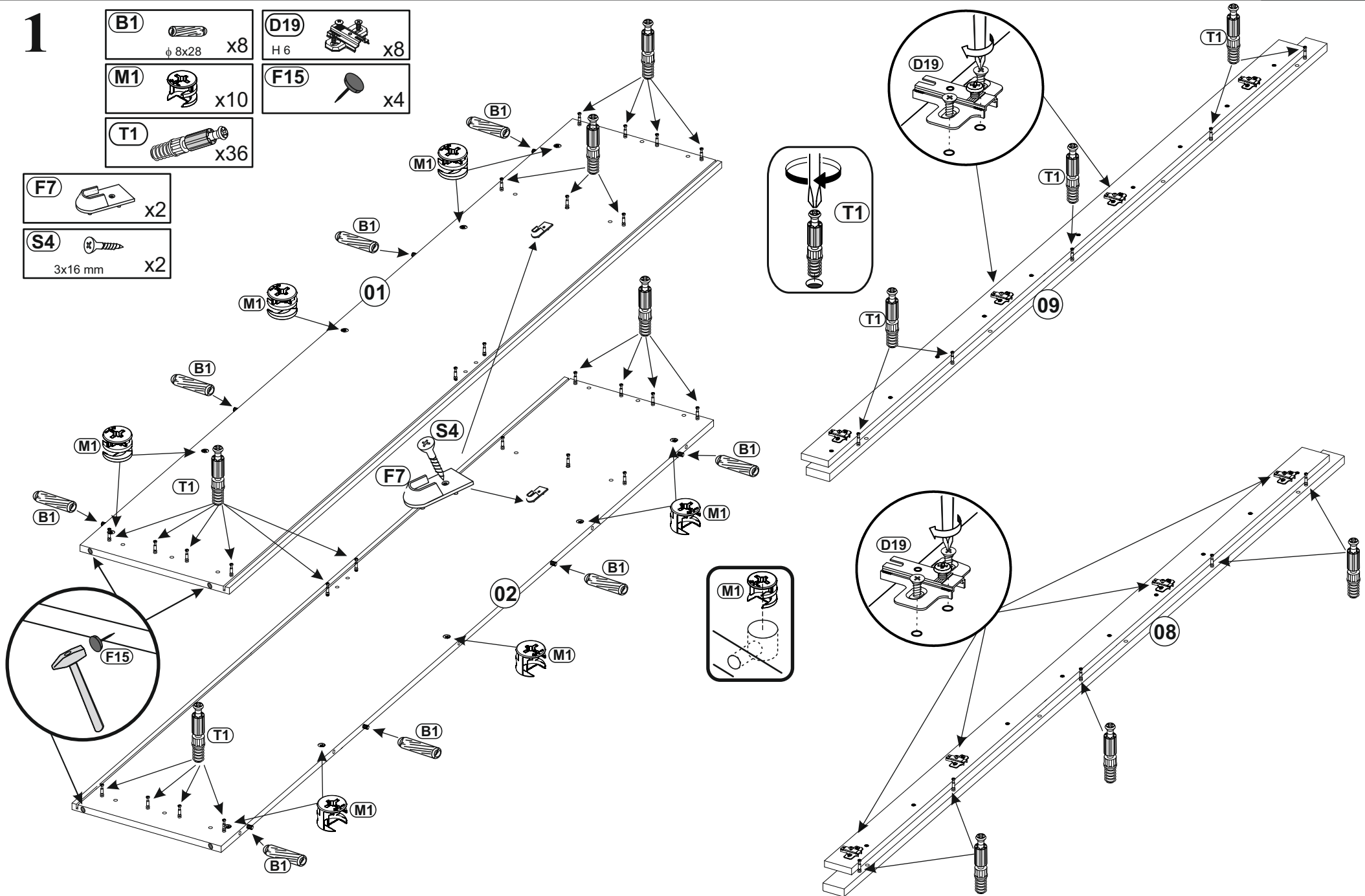
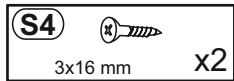
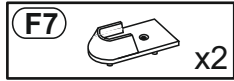
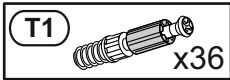
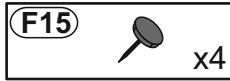
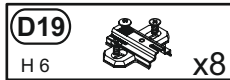

# 1



2

- L1**  x1
- B1**   $\phi$  8x28 x33 x33
- M1**  x26

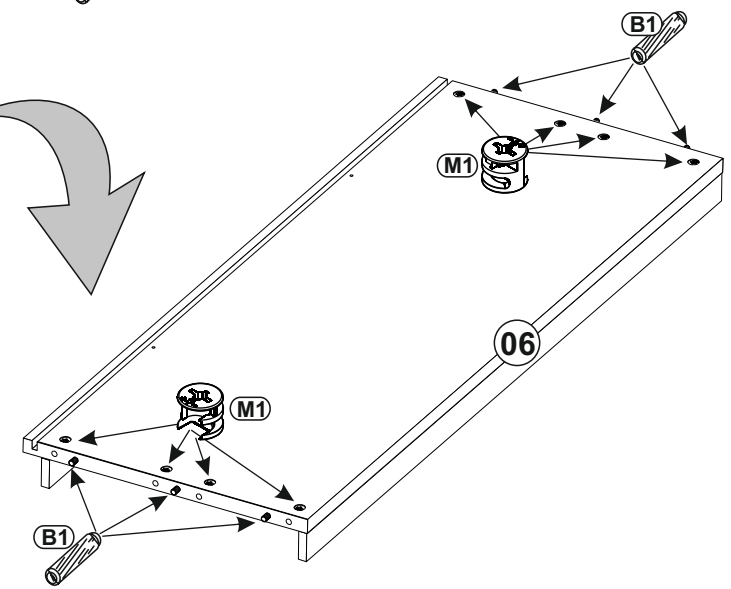
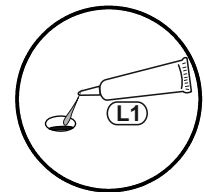
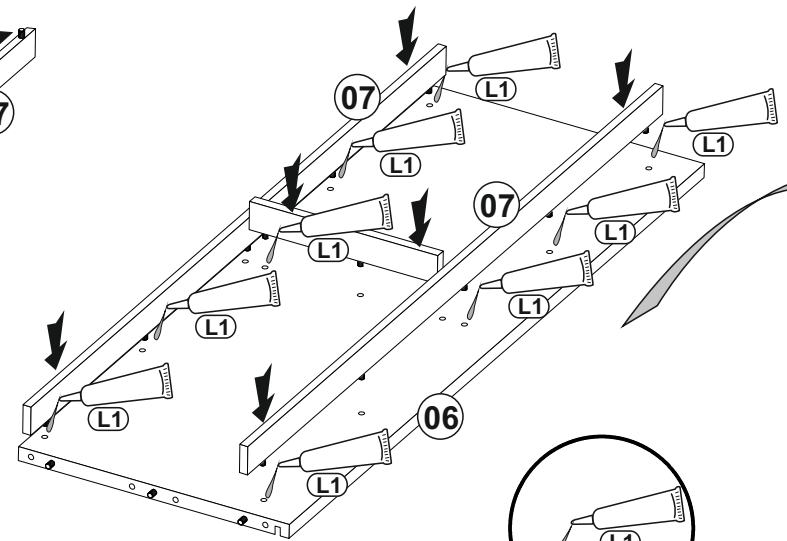
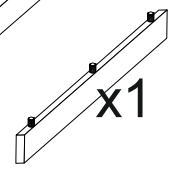
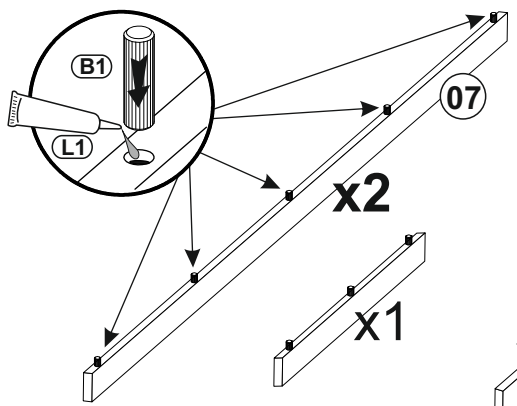
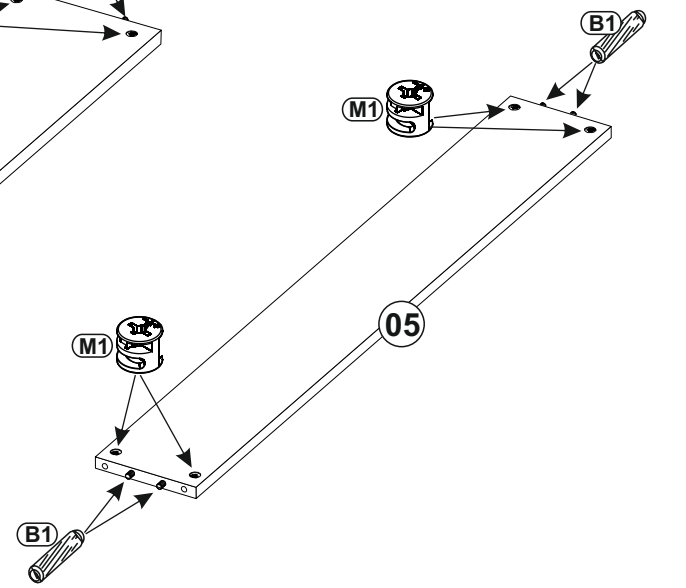
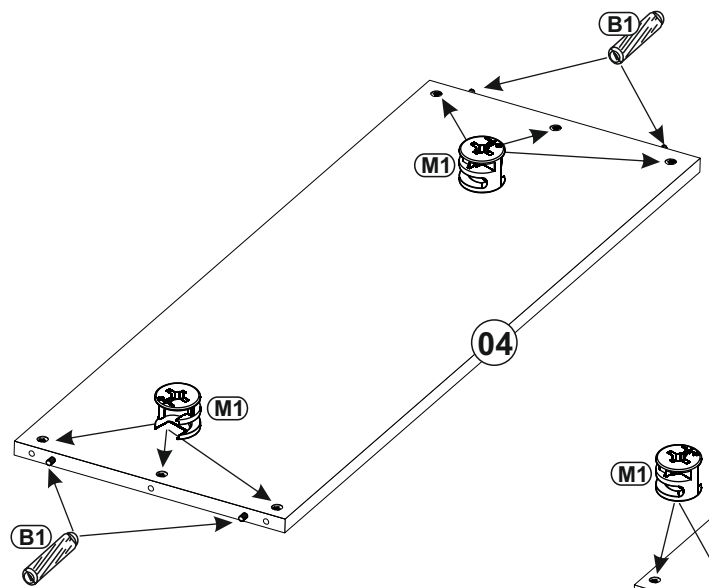
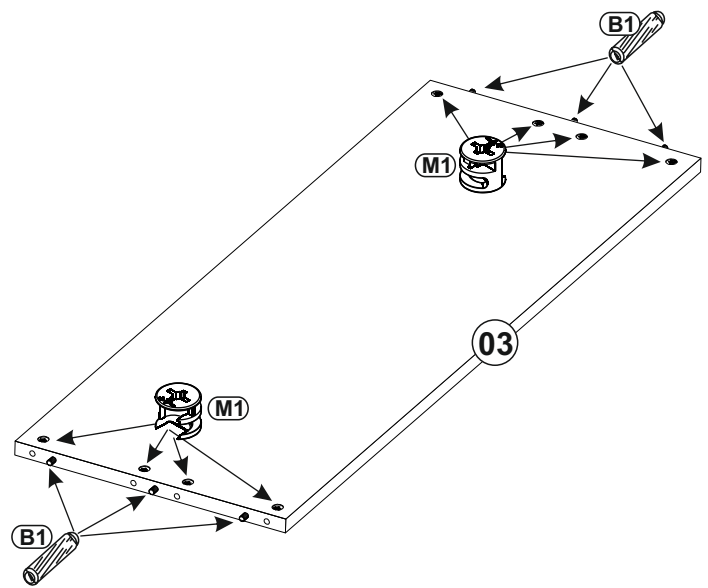

3

**Z26**  
KR 90 x4

**Z26** cichy domyk  
KR 90 x4

**S9**  
4x16 x16

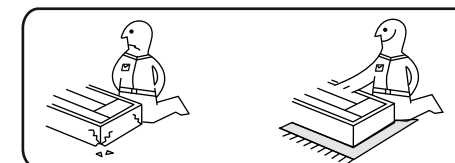
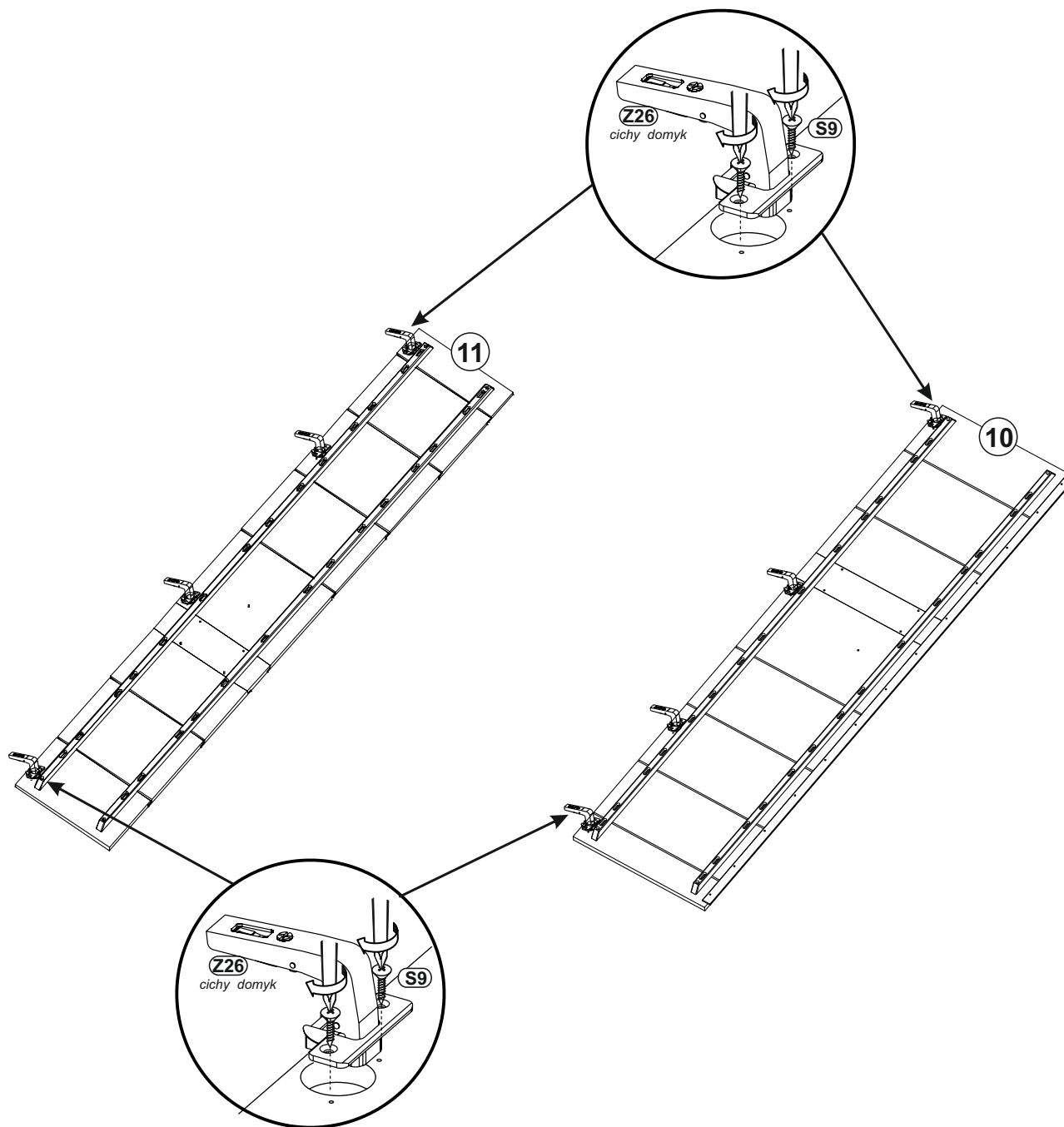

4

5

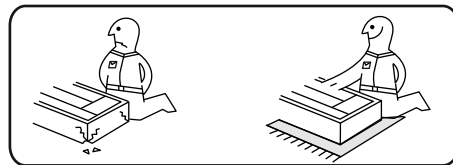
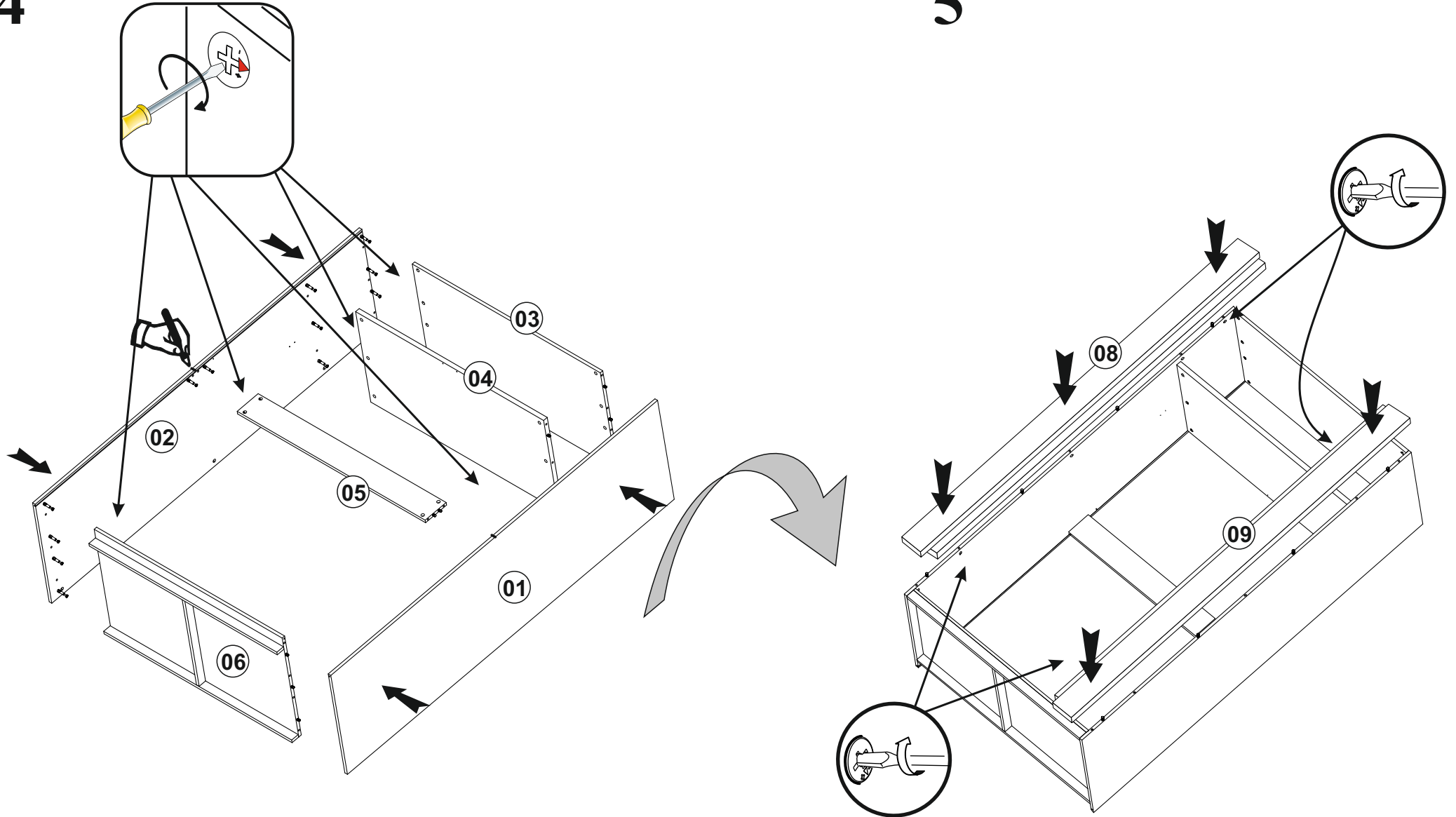

6

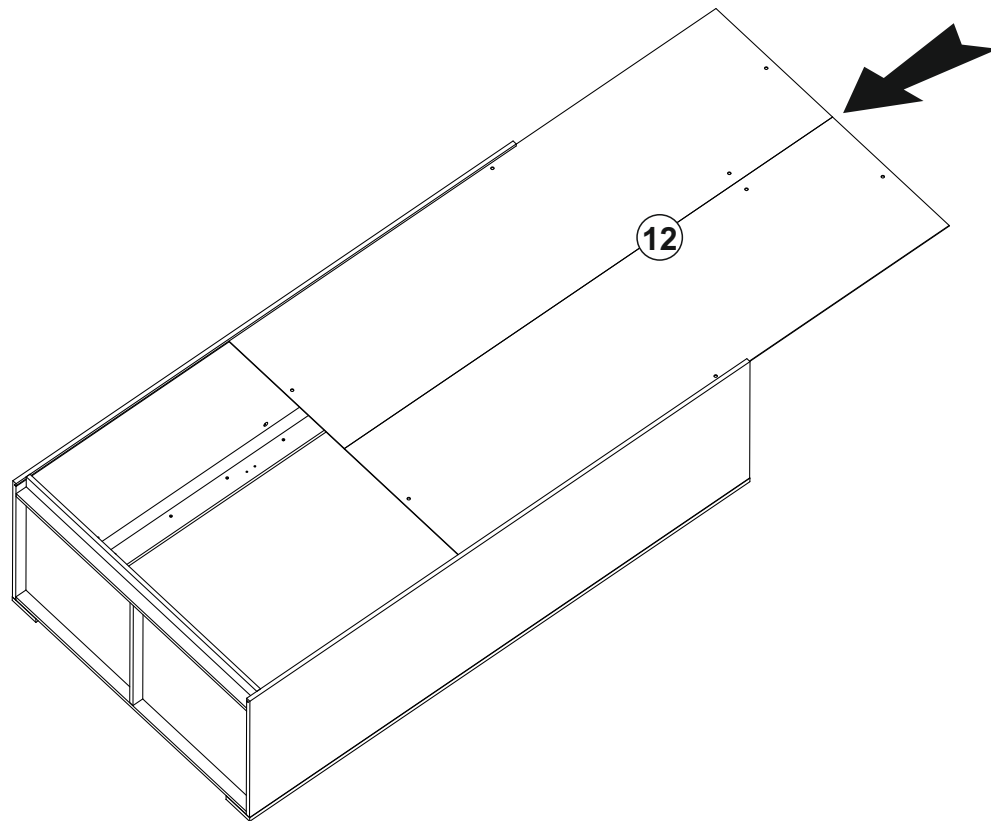

7

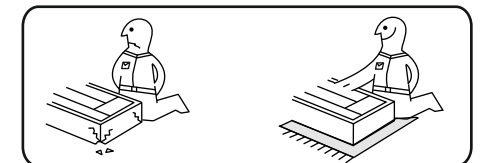
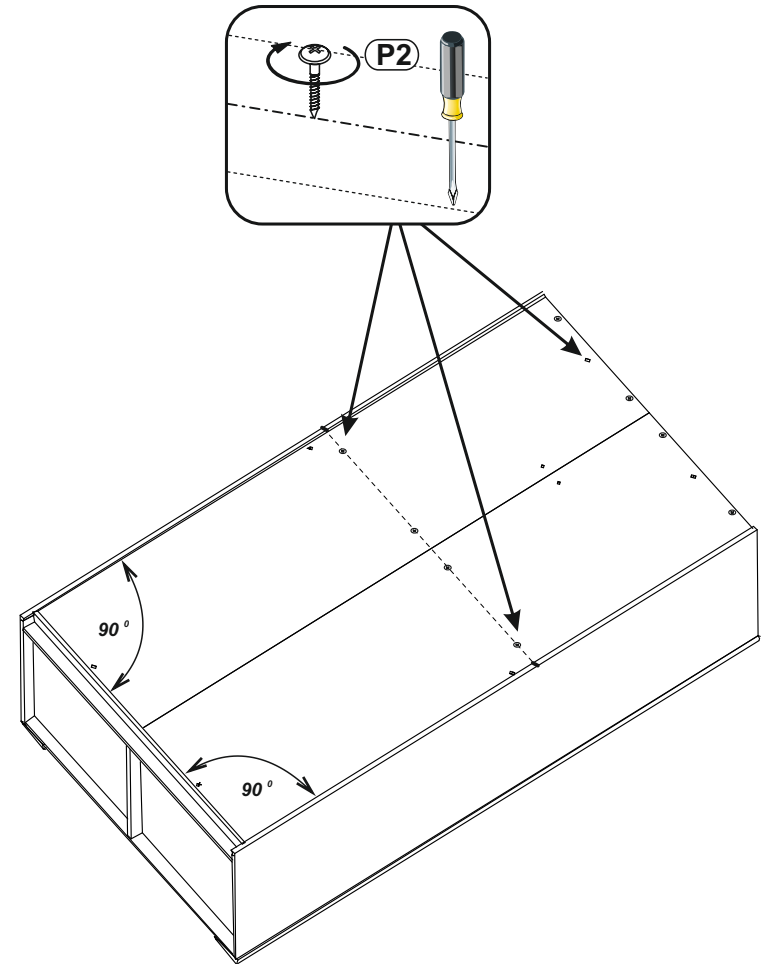

## 8

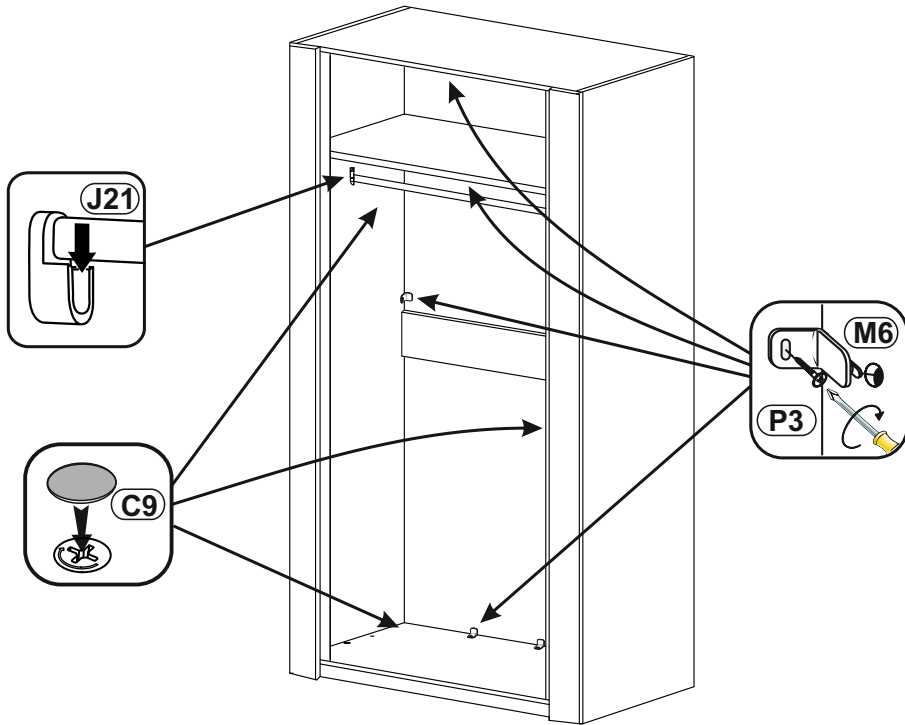
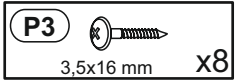
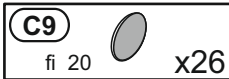

## 9

